

Faint, illegible text, possibly bleed-through from the reverse side of the page.









10 - [Illegible text]

11 - [Illegible text]

12 - [Illegible text]

13 - [Illegible text]

14 - [Illegible text]

15 - [Illegible text]



oado. Entre líneas: "tiende" - vale.

- Esta Memoria consta de once hojas escritas por una sola cara.

Madrid, 2 de Enero de 1926

P. á.
Alberto de Elzaburu
Por Poder

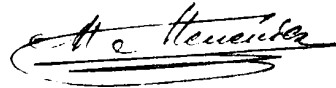

ESCALA VARIABLE



FIG. 1.

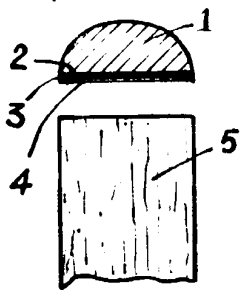

FIG. 2.

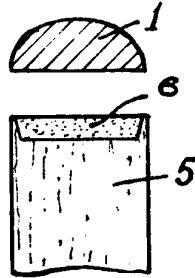

FIG. 3.

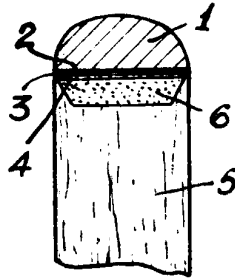

FIG. 4.

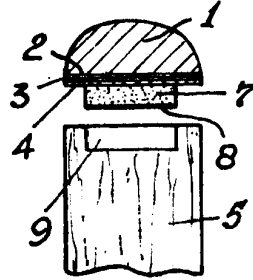

FIG. 5.

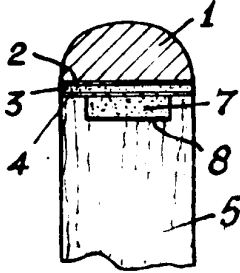

FIG. 6.

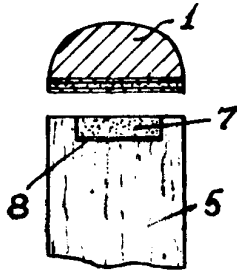

FIG. 7.

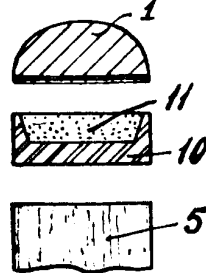

FIG. 8.

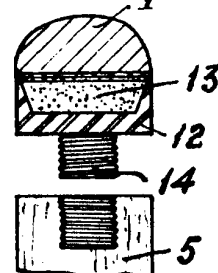

FIG. 9.

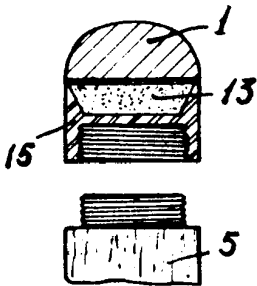

FIG. 10.

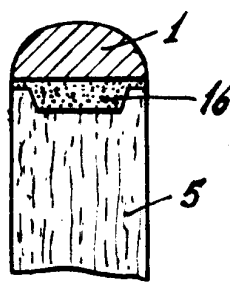

FIG. 11.

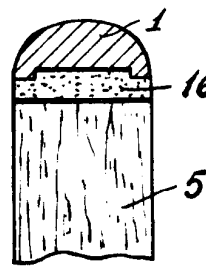

FIG. 12.

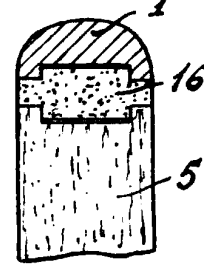

FIG. 13.

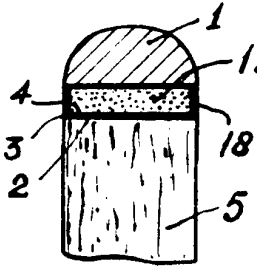

FIG. 14.

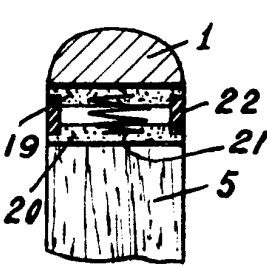

FIG. 15.

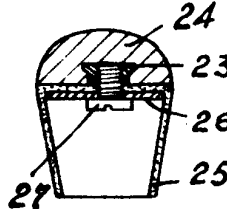

FIG. 16.

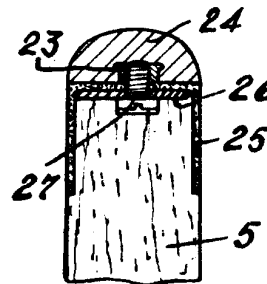

FIG. 17.

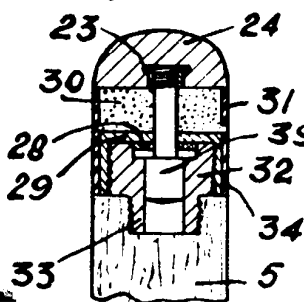

FIG. 18.

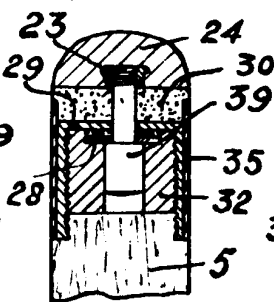
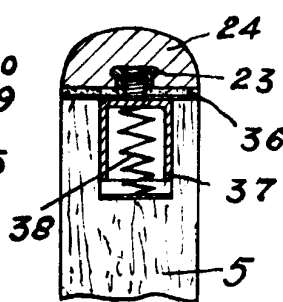

FIG. 19.



P.A.
Alberto de Elzaburu
Por Poder

U. Gonzalez